

HF/50MHz Transceiver  
**FT-2000 Series**



Shown with after-market keyer paddle, keyboard, and monitor (not supplied). Optional Data Management Unit (DMU-2000) and monitor are required for viewing of Audio Scope and other display features.

**The radio... YAESU**  
 Choice of the World's top DX'ers

# HF Excitement

## HF operation is more enchanting than ever...

In today's world of e-mail and the Internet,  
it's possible to communicate effortlessly with anyone in the world.

So why is it that Hams are more and more enchanted by the lure of HF DX every day?

It's because the romance of HF DX is more alive than ever.

With every advance in our understanding of the ionosphere, more questions arise,  
and we want the ability to pull imperceptible signals out of the swirling plasma storms above us,  
unlocking the mysteries of how the signals get from "there" to "here."

That wondrous moment when you hear the rare DX station coming back only to you.

It's a feeling that can only be appreciated by someone with the soul of a DXer.

It's called the "Magic of DX" and it's what HF operation is all about.

That primal need to explore, to know who is out there, and to find out first-hand.

And the magnificence of Nature can only be truly appreciated when  
you have the best technology connected to your antenna, allowing you to hear like never before.

And, of course, it's not just the fact of making the QSO that makes DXing magical...  
it's the path you follow on the way to the destination!

## The DXer's Choice: FT-2000

It's a dynamic natural and man-made environment in which DXers perform their magic on the airwaves.  
So it's not enough just to hear a signal and then call back in the hope of making a QSO.

But when you make the decision to invest in a radio that makes you a partner with  
the DX station so far away, only then can you realize the total DX experience!

## YAESU brings you innovation and quality you just won't find elsewhere!

The FT-2000 is the 2nd Generation of the proud lineage of the FT DX 9000 Series, which represented a  
quantum leap in HF transceiver performance when it was introduced in 2005. Now, the FT-2000 takes its  
own place as a new benchmark in performance,  
following the elite-class success of the MARK-V FT-1000MP.

The FT DX 9000, widely acclaimed for its unmatched total system performance,  
broke new ground in design with such ultra-high-performance features as the high-Q  $\mu$ -Tuning and VRF  
Preselector systems in the receiver front end, as well as the superb interference-rejection capability of its IF DSP.

These same capabilities can be yours with the FT-2000.

Add the optional DMU-2000 Data Management Unit, and you can also utilize the powerful Audio Scope,  
Oscilloscope, Spectrum Scope, Logging, and Rotator Control capabilities,  
using your own computer monitor (not supplied).

Witness the birth of the newest and most powerful DX Transceiver ever: the YAESU FT-2000.

**High-speed Direct Digital Synthesizer (DDS) and  
200 MHz High-spec Digital PLL for Outstanding Local Oscillator Performance**

**1st IF 3 kHz Roofing Filter Included**

**Triple-Conversion Receiver Design using 69.450 MHz 1st IF**

**Ultra-strong Receiver Front End Includes Bandpass Filters and Variable RF (VRF) Preselector**

**IF WIDTH, IF SHIFT, NOTCH, and CONTOUR Features Included  
Advanced Multi-function 30 kHz 32-bit Floating Point IF DSP**

**Dual Receive (in-band) utilizing Fully Independent Receiver IF Systems**

**Class-A Transmitter Operation (200-Watt version)**



# FT-2000 Series

FT-2000D 200 W Version with External Power Supply  
 FT-2000 100 W Version with Internal Power Supply

## High-performance Receiver Design utilizing System-wide Gain and Intercept Balancing

### Triple-conversion Receiver Design with Optimized Stage Balance

Designed with the same emphasis on efficiency as used with a transmitter, the receiver design of the FT-2000 is centered around optimization of each stage's gain, intercept, and selectivity. The triple-conversion design features a 1st IF of 69.45 MHz, a 2nd IF of 450 kHz, and a 3rd IF of 30 kHz (FM: 24 kHz), and each stage's advanced filtering protects the stages to follow from unwanted signal voltage, leading to a quiet, ultra-robust receiver with impeccable total system performance.

### Robust Receiver Front End

The RF amplifier stage is designed for low and high intercept, utilizing two strong series-connected 2SC3356 bipolar transistors with negative feedback for consistent, repeatable performance. The front-panel IPO switch lets you select direct feed to the first mixer (IPO), Preamp 1, or

Preamp 2 (which adds the second preamplifier stage in series), according to the antenna in use and the noise and interference conditions present at the time. The low noise figure and carefully-controlled stage gains ensures that only the precise amount of gain needed is actually utilized. IPO (Intercept Point Optimization) is the function which allows you to set the total front end gain, so as to optimize RF stage performance. The ultra-strong first mixer of the FT-2000 features SPM5001 FETs in an active, doubly-balanced configuration optimized for a multi-signal environment. The active design results in no net loss in the mixer circuit, often eliminating the need for preamplification prior to direct feed of received signals to the first mixer.

### Dual Receive (In-band) Featuring Independent IF Strips

The sub receiver of the FT-2000 is an analog type, with a completely independent IF section so that strong signals appearing on the main receiver do not affect signals on the sub receiver. This brings you the true benefits of dual receive operation. The IF passband of the sub receiver may be varied between 2.4 kHz and 1.1 kHz, and an optional Collins® Mechanical Filter of 500 Hz (YF-122C) or 300 Hz (YF-122CN) may be added, for sharper selectivity on CW.

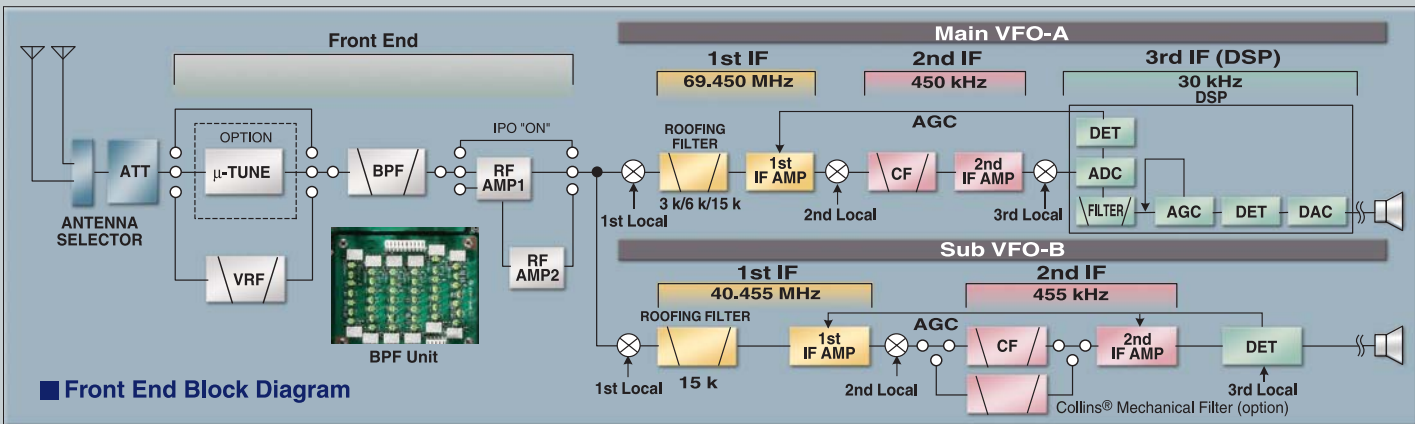

### Variable RF Preselector (VRF) Covers the 1.8 - 28 MHz Amateur Bands

To provide protection for the RF stages, as well as the three IF stages, the front end filtering system utilizes a combination of twelve fixed bandpass filters and Yaesu's exclusive VRF (Variable RF) Preselector system. These two RF filter systems protect the early stages of the receiver from overload caused by strong out-of-band signals. The high-Q VRF system, much narrower in bandwidth than the fixed bandpass filters, are crafted using high-permeability toroidal coils (T-80 and T-37 type) and tuning capacitors, producing 44 tuning steps for optimal of broadcast or commercial-service interference. The robust circuit design utilizes expensive sealed surface-mount relays, capable of sustaining surges of up to 2500 Volts down the antenna line. The center frequency of the VRF is manually adjustable, allowing you to skew the filter response for maximum rejection of the undesired signals.



VRF Unit

VRF: Graphic Representation of Center Frequency Position

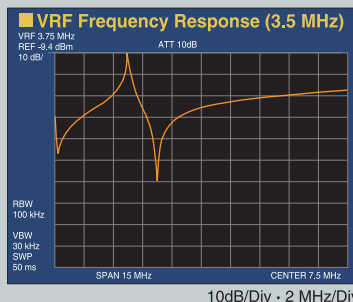

### First IF 3 kHz Roofing Filter is Factory Installed

The 69.450 first IF of the FT-2000 features three roofing filters, in bandwidths of 15 kHz, 6 kHz, and 3 kHz, optimized by mode for best performance on today's crowded bands. Each roofing filter is a four-pole, fundamental-mode monolithic crystal filter design to produce excellent shape factor. Especially useful during busy contest weekends, the roofing filters are positioned right after the first mixer, improving IP3 (3rd-Order Intercept Point) performance for all stages that follow.



Three-section Roofing Filter Stage

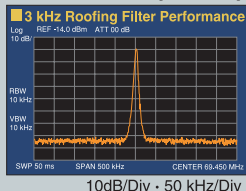

### High-speed Direct Digital Synthesizer (DDS) and 200 MHz High-spec Digital PLL for Outstanding Local Oscillator Performance

In seeking to improve the strong-signal-handling capabilities of the receiver section, in a multi-signal environment, the YAESU design team has developed a high-spec, ultra-low-noise local oscillator system that produces a very clean first IF signal. The high Carrier-to-Noise (C/N) ratio of the 200 MHz high-speed digital PLL is the result of very fast lock time, because the local design does not entail the use of a prescaler but rather locks directly on the 1st local frequency. As a result, the spurious-free dynamic range and close-in blocking performance are substantially enhanced.

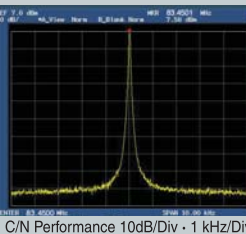
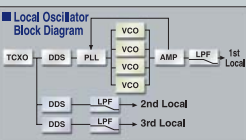

# Yaesu's renowned engineering know-how is now applied to the world of IF DSP, and the FT-2000's 32-bit floating point IF DSP is crafted to give your station the edge over all other DSP-based radios

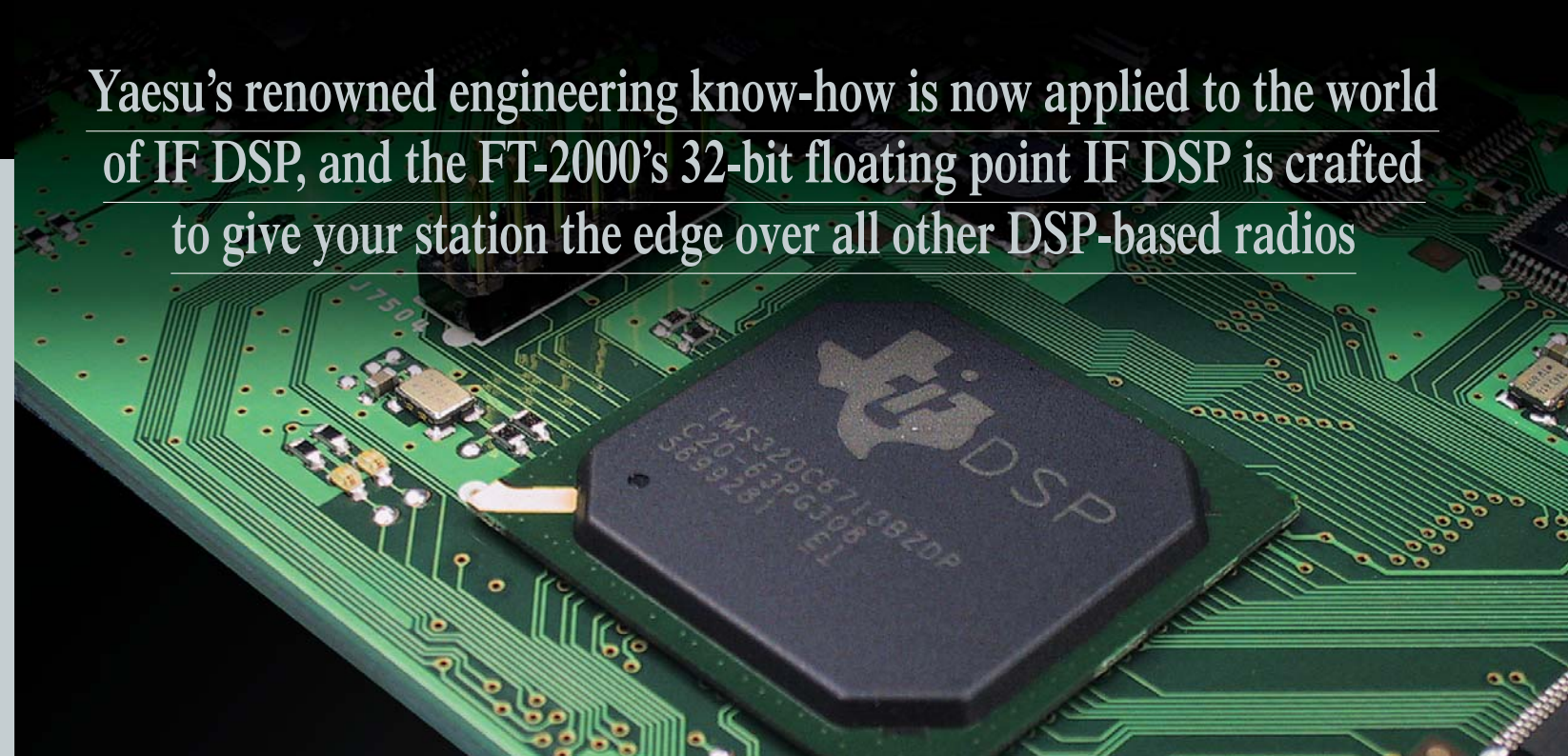

The IF Digital Signal Processing system of the FT-2000 is based on the TI TMS320C6713 32-bit floating point DSP IC.

### World-renowned Variable IF WIDTH and IF SHIFT Interference-reduction Systems

The IF Shift system is highly effective for removing interference. While leaving the pitch of the incoming signal unchanged, as well as the bandwidth of the IF passband, the IF Shift system allows you to vary the passband higher or lower in frequency, eliminating interference that you tune outside the passband. The IF Shift control is concentric with the IF WIDTH control. The Variable IF WIDTH system has a default center bandwidth of 2.4 kHz for SSB and CW, and 500 Hz for RTTY and PSK operation. By rotating the IF WIDTH control, the passband maybe reduced to as little as 25 Hz on CW/RTTY/PSK, or 200 Hz on SSB. What's more, if you like to listen in a wider bandwidth for greater fidelity on SSB, the SSB bandwidth may be expanded to 4000 Hz by simply rotating the IF WIDTH control clockwise.

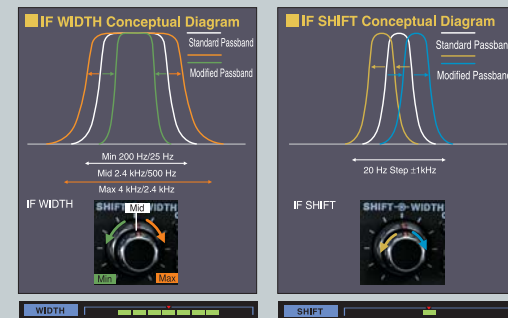

### Passband Response CONTOUR Control with an Analog Touch

The incredibly sharp "brick wall" filters of the IF DSP system can expose characteristics of incoming signals that you've never heard before, not all of them pleasant to listen to. But, using the CONTOUR control, you can roll off low-frequency or high-frequency components so as to shape the receiver passband differently, or null out part of the mid-range area, with continuous adjustment throughout the passband. By nulling out interfering or irrelevant frequency components, the desired frequency components are allowed to rise out of the background noise, improving fidelity and signal-to-noise ratio.

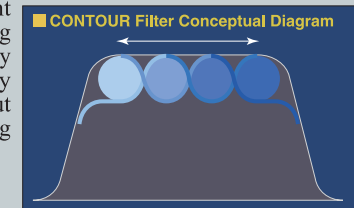

### Manual IF Notch and Beat-reducing Automatic Digital Notch Filter (DNF)

The IF Notch features very high Q, producing a deep notching effect typically in excess of 70 dB. Using the Menu mode, either a "Wide" or "Narrow" notch filter can be selected, depending on the interference profile you are encountering. To aid in tuning such a high-Q filter with precision, concentric [COARSE] and [FINE] tuning parameters for the IF Notch are provided, yielding the ability to adjust the Notch filter precisely yet effortlessly. And, for reduction of multiple carriers within the passband, the DSP Auto Notch (DNF) filter may be engaged, independently from the manual Notch Filter.

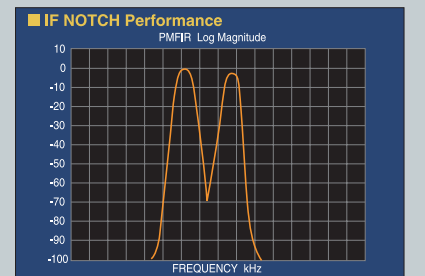

### DSP Digital Noise Reduction

For reduction of random noise types, the FT-2000 utilizes a powerful Digital Noise Reduction filter, which contains sixteen different noise analysis parameters specially created after hundreds of hours of on-air testing. The operator may choose any of these parameters to reduce noise most effectively, based on noise conditions at any given time.

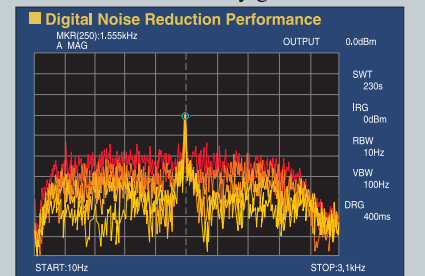

### Analog-sounding High-quality Digital SSB Modulation

The FT-2000 utilizes a phase-shift digital modulation technique that not only provides a analog-sounding high-quality digital SSB modulation envelope, but it also allows the transmission bandwidth to be adjusted by the operator.



# Unlock the Secrets of the Low Bands

YAESU's Exclusive, Fully-Automatic  $\mu$ -Tuning Preselector System!



## Fully-automatic External $\mu$ -Tuning Ultra-sharp Preselector (option) features 1.1" (28 mm) Coil for High Q

On the lower Amateur bands, the signal voltages impinging on a receiver can create noise and Intermodulation effects that can cover up weak signals you're trying to pull through. So YAESU's engineers developed the  $\mu$  (Mu) Tuning system for the FT DX 9000, and it's now available as an option for the FT-2000. Three modules are available (MTU-160, MTU-80/40, MTU-30/20), and these modules may be connected externally with no internal modification required! When  $\mu$ -Tuning is engaged, the VRF system is bypassed, but the fixed Bandpass Filters are still in the received signal path.

The  $\mu$ -Tuning filters utilize a stack of large 1.1" (28 mm) Ni-Zn Ferrite cores, driven through a silver-plated coil assembly by a precision stepper motor. The resulting high Q (typically over 300) provides a very steep resonance peak near your operating frequency. The typical 160-meter bandwidth, at -3 dB, is  $\pm 12$  kHz, and at -30 dB the bandwidth is typically  $\pm 450$  kHz. The peak may be adjusted away from your frequency, for even greater protection from a specific station, and a graphical depiction of the  $\mu$ -Tune filter alignment appears on the front panel of the transceiver. And, within the  $\mu$ -Tune passband, the 3rd-order Intercept Point is increased by 4 dB.

The ferrite cores utilized in the  $\mu$ -Tune filters are driven by a high-resolution, high torque stepper motor (4-phase unipolar motor/2-phase magnetization system) with angular resolution of  $1.8^\circ$ , and the synchro belt drive has an estimated lifetime of 10,000 hours of actual operation. For 160-meter operation, the ferrite core diameter is 2.2" (55 mm), and on all modules the  $\mu$ -Tune system tracks your operating frequency, although you can manually skew the frequency response when special interference conditions require it.

If you turn the  $\mu$ -Tune system off, just a press of the [VRF] switch will re-engage the  $\mu$ -Tune system, re-centering the  $\mu$ -Tune filter on your current operating frequency.

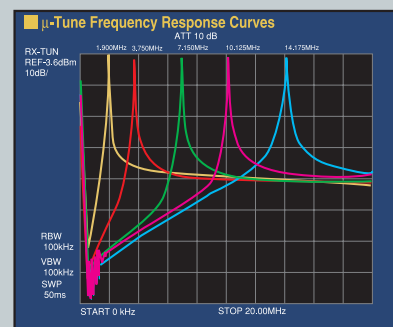

10dB/Div - 2 MHz/Div



Large-Area (1 1/8" 28 mm) Coil (Actual Size)



High-durability Synchro Belt Drive and High-resolution Stepper Motor



Inside the  $\mu$ -Tune Unit

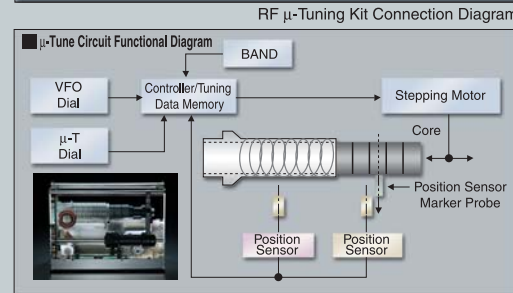
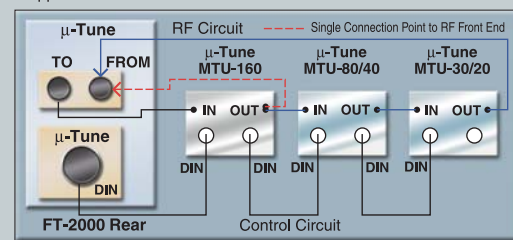

# FT-2000 Series

## Superb Viewing and Display Clarity, in the FT DX 9000 Tradition

### High-accuracy Analog Meter

In order to ensure maximum accuracy in power and other measurements, an oversized, crystal-clear analog system is used on the FT-2000. With excellent contrast and illumination provided by white LEDs, the analog meter system may be toggled for viewing of Speech Processor Compression level, ALC level, SWR, final amplifier voltage, and final amplifier current.



### Proprietary High-visibility Fluorescent Display (VFD)

The oversized VFD display provides higher brightness and contrast compared to TFT displays, allowing clearer viewing from a wider range of angles than on other transceivers. The Main band frequency is shown in bright blue, while the Sub band is shown in white, for instant recognition.



### Unique "Block Diagram" Display Shows Receiver System Status Instantly

The upper left area of the display contains a unique "Block Diagram" display, showing the current status of a number of functions in the receiver of the FT-2000. Included in the displays are Antenna selection, Front-end Attenuator, Preselector (VRF or  $\mu$ -Tune), Preamplifier selection, Roofing Filter selection, and AGC response time. You also get Bar Graphs depicting several different DSP filter settings, for quick alignment.

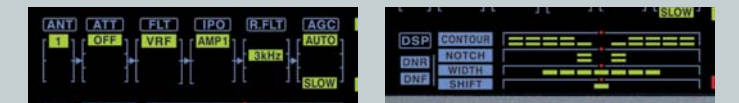

### Independent Analog Clarifier Display

For effortless offset tuning with a completely analog feel, the RX and TX Clarifiers included in the FT-2000 are an operator's dream come true. Whether operating a modest split in a DX pile-up, or compensating for some stations in a local ragchew being off frequency, The Clarifier system of the FT-2000 is simple to operate, and the offset display, both numerical and graphic, is easy to read, with one-touch resetting to a "zero" value, if desired.



Clarifier Dial and Keys

### Quick Split Feature

Pressing the [SPLIT] key for two seconds or more engages the "Quick Split" feature, which automatically separates the receive and transmit frequencies by 5 kHz (the TX frequency will be 5 kHz higher). For other Split operating situations, just press the combination LED/switches near each VFO dial to set the VFOs as you want them.

### Tracking Feature

During Split operation, you may command the FT-2000 to operate in a "Tracking" mode whereby the Sub VFO frequency tracks the frequency change on the Main VFO, maintaining a constant split between the two frequencies. You can even do "Band Tracking" whereby you can cause both bands to change simultaneously, using this feature.

### TXW (Transmit Frequency Watch) Feature

When operating Split, pressing the [TXW] key instantly lets you receive on your transmit frequency, to hear activity in the pile-up you are working to break through.

### Preset NARROW Switch

While the WIDTH control is generally used for setting of the IF DSP bandwidth, a one-touch [NARROW] key is provided, allowing you instantaneous access to a bandwidth narrower than the default value on the current operating mode. For SSB, for example, where the default bandwidth is 2400 Hz, you have "Narrow" selections available of 200/400/600/850/1100/1350/1500/1650/1800/1950/2100/2250 Hz, while on CW, "Narrow" selections of 25/50/100/200/300/400/500/800/1400/1700/2000 Hz are available. So, for example, you can set up "Narrow" bandwidths of 1.8 kHz for SSB, 500 Hz for CW, and 300 Hz for RTTY and PSK operation. What's more, for AM Broadcast operation, you may use the [NARROW] key to toggle between bandwidths of 6 kHz and 9 kHz, depending on interference.

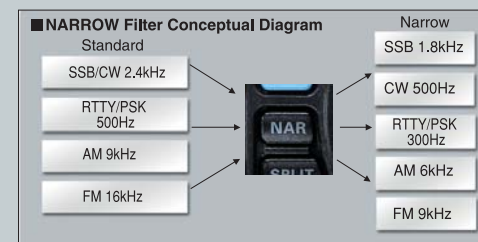

### IF Noise Blanker

The IF Noise Blanker is ideal for suppression of automotive ignition noise, and it may be utilized in conjunction with the Digital Noise Reduction system, or by itself. A front-panel Noise Blanker gain control allows precise control of the blanking level to be applied, and both wide and narrow pulse noises may be suppressed using this feature.

### Sloped AGC Feature

During certain conditions whereby both weak and strong signals are being encountered, a "flat" AGC response (whereby signals above a certain level are all clamped so as to produce the same audio output) may not be optimal. So the FT-2000 menu lets you select a traditional "flat" response or a "Sloped" response, whereby louder signals are allowed to rise up to a slightly higher level than are weak signals, thereby allowing you to use your brain to discriminate between signals according to signal strength, not just frequency characteristics. This provides superior signal recognition during contest pile-up operating situations.

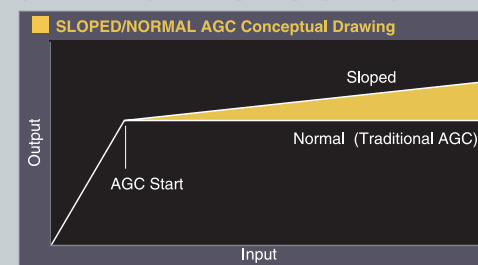



# The Joy of Operating. . .

# Ultra-Clean Transmitter Design



Actual Size

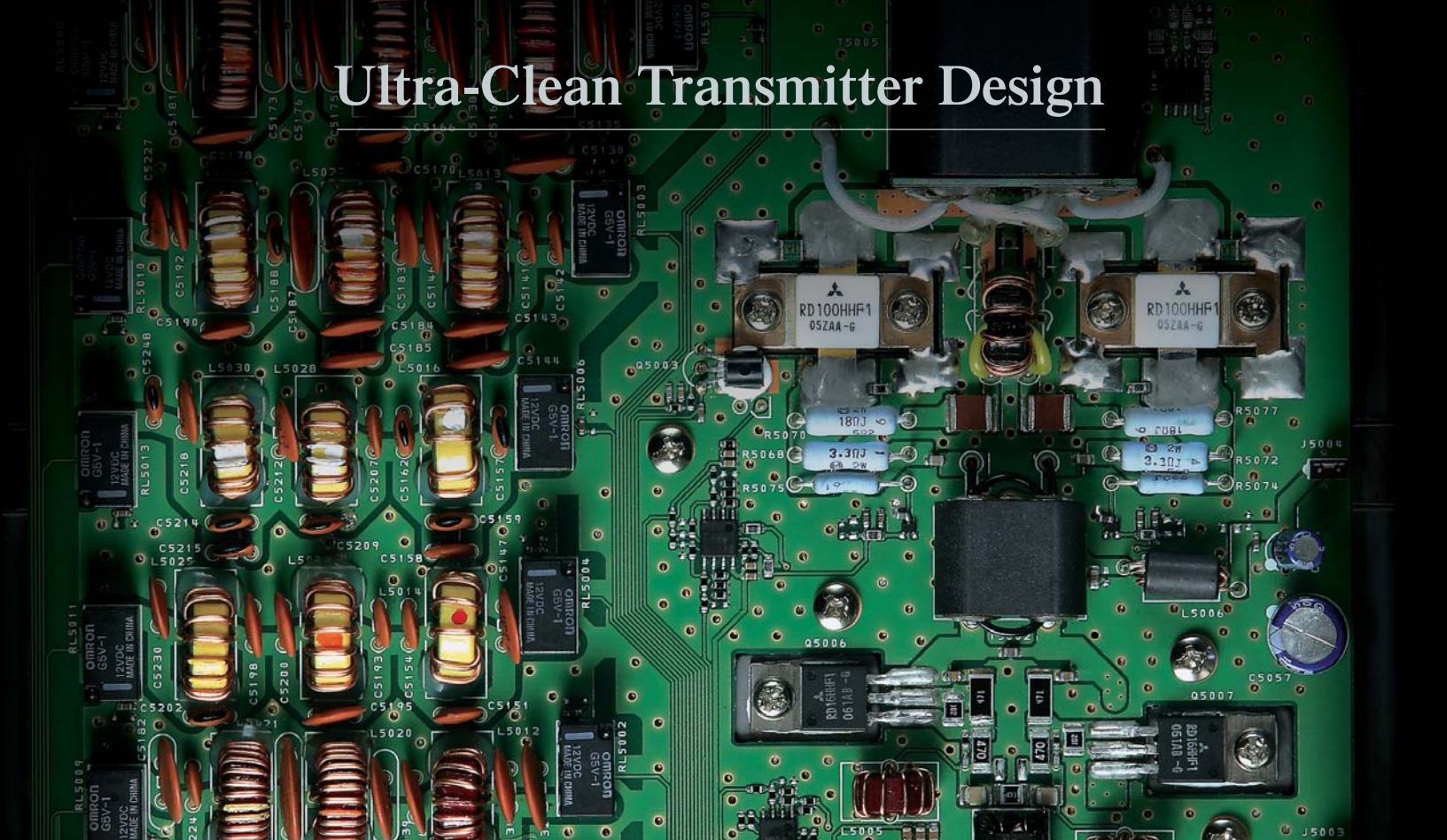

## Flywheel-effect Oversized High-quality Main Tuning Dial

- The front panel's oversized 2.67" (68 mm) Main Tuning Knob is crafted using a heavy brass alloy (knob weight: 6.7 oz./190 g), for easy flywheel-effect frequency excursions or precision tuning of weak digital signals, thanks to the precision magnetic rotary-encoder tuning mechanism coupled to the Main Tuning Knob.
- The torque of the tuning knob shaft may be adjusted, by rotating the Main tuning Knob while holding the dial skirt, for just the amount of drag you prefer. All it will take is one spin of the dial for you to know that you are in command of a serious radio.
- The Main Tuning Dial is the same structure as used on the FT DX 9000, utilizing the normal dial structure along with a rotating skirt that creates a small air gap. This air gap reduces sweat accumulation on the operator's fingertips, enhancing tuning precision during long operating sessions, especially on DX-peditions to hot tropical areas.



- Just as on the FT DX 9000, the most important switches for operational control are arrayed around the Main Tuning Knob, making the FT-2000 and ergonomic delight. Included are memory control, narrow filter selection, QMB (Quick Memory Bank) keys, and VFO selection and command keys surrounding the knob, with operating mode selection in the next row to the left.

## Interference-reduction Controls are Arrayed on the Right Side of the Front Panel

The most important interference-reduction controls, including VRF/ $\mu$ -Tune adjustment, IF Shift, IF Bandwidth, Contour, DNR, IF Notch, and DNF are all arrayed close to each other on the right side of the front panel, so your hands never need to wander far when battling tough QRM.



## Multi-Function Dial for Speedy Operational Commands

At the bottom right corner of the front panel is a "multi-function" knob that serves a number of important purposes. Its most-often-used tasks include VFO-B and Clarifier (offset) tuning, and the large diameter makes precise tuning effortless. When operating in the VFO-B mode, moreover, this knob may be used for tuning in 100 kHz or 1 MHz steps (for quick "general coverage" band change), as well as operating mode selection for VFO-B. When operating in the "VFO-B" mode, the outer circle lights up in orange, matching the color of the VFO-B labels, thus preventing operator confusion and errors.



- Band Stacking VFOs provide Frequency and Mode Memory for Effortless Operation.
- 10-Key Direct Keyboard Frequency Entry

## High-power, Super-stable Final Amplifier Stage

The FT-2000 incorporates a pair of reliable RD100HHF1 MOS FETs in a push-pull configuration, using a supply voltage of 13.8 Volts. They are cooled using a huge 1400 cc die-cast aluminum heat sink with a high coefficient of thermal conductivity. A thermostatically-controlled 3.6"/92mm axial cooling fan engages at 40° C, and it features five speeds, depending on the degree of cooling required. The large bearing surface of the fan, its "floating" mount, and the unique heat sink design combine to make the cooling system ultra-quiet, yet very efficient.

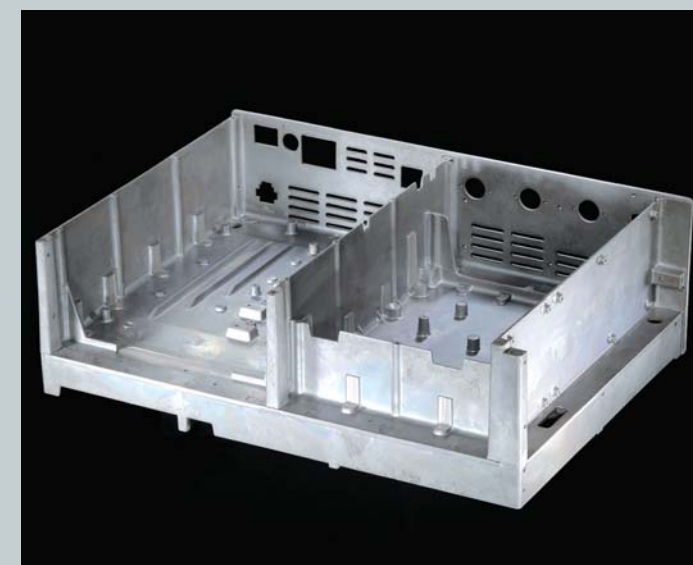

The FT-2000D (200-Watt version) utilized push-pull SD2931 MOS FET devices, operating at 50 Volts, with user-adjustable bias control to ensure the optimum suppression of intermodulation distortion products. The elaborate heat sink design includes a combination of aluminum and 3 mm thick high-conductivity copper plate, with a total heat sink capacity of 2720 cc, ensuring many years of reliable operation of this 200-Watt powerhouse.

## Ultra-low Distortion Class-A Final Amplifier (200-Watt FT-2000D version)

The 200-Watt FT-2000D includes provision for operation in a "Class-A" mode at 75 Watts of power output, utilizing high bias current to produce very low transmitter intermodulation products; 3rd-order IMD is typically suppressed 50 dB or better, and 5th- and higher-order IMD is typically suppressed 70 dB or more! You may adjust the bias level between Classes A and AB, depending on ambient temperature in your station, the duty cycle associated with contest or DX-pedition use, etc.

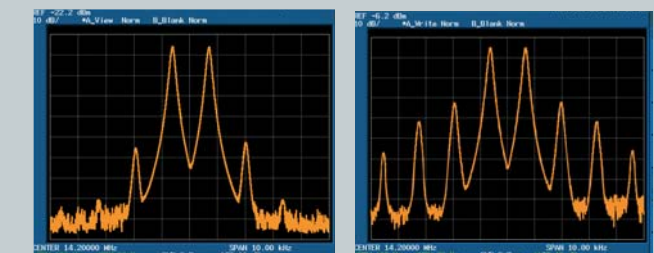

Class A: Ultra-Low TX IMD      Class AB: Typical IMD at 200 W PEP Output

## 200-Watt Version Features External Power Supply

The adoption of an external power supply reduces the amount of heat circulating inside the transceiver case, leading to greater reliability and long-term stability. The FT-2000D's external power supply provides 50 volts at 10 Amps, and 13.8 Volts at 5 Amps.





## High Speed Automatic Antenna Tuner

Re-visiting the matter of Automatic Antenna Tuner design, with an eye to increasing tuning speed while not sacrificing tuning accuracy, the FT-2000 design team incorporated a new drive system using a stepper motor. The 100 memories of matching-point data allow you to tune around the bands without the need to re-tune as you go. The special antenna tuner memories ensure efficient operation, as well as lightning-fast matching at new operating frequencies, as needed.

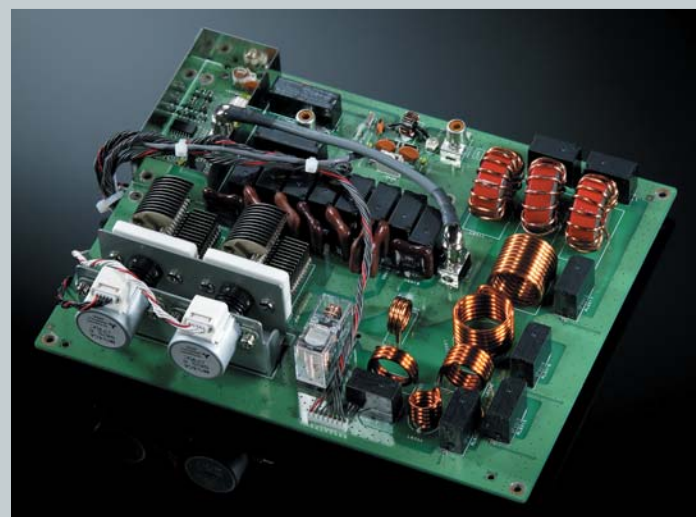

## Parametric Microphone Equalizer

The Three-Band Parametric Equalizer provides the FT-2000 user with simply unmatched capability to equalize a microphone and voice characteristics optimally. Within each of the three bands (low-frequency, mid-range, and high-frequency) provided, you may adjust the center frequency of the equalization, the bandwidth over which the equalization is applied, and the amplitude (either peaking or nulling) within that range. Independent Equalizer settings are provided for when the DSP Speech Processor is on and off.

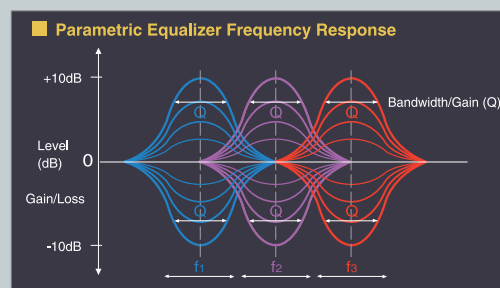

## Renowned YAESU Speech Processor for that Contest or DX Pile-up Punch

The power of IF DSP is brought to the world of Speech Processing, with the powerful new DSP Speech Processor design incorporated into the FT-2000. Crafted to increase intelligibility at the receiving side of a difficult path, the Speech Processor includes its own set of Parametric Equalizer settings, so the optimum frequency response may be obtained. The compression level for the Speech processor may be adjusted from the front panel.

## Transmit Monitor Feature

The IF Transmission Monitor allows you to listen to a faithful reproduction of the transmitter's IF signal, for making precise adjustments to the Parametric Equalizer, SSB Bandwidth, and/or Speech Processor. The Monitor Level may be adjusted from the front panel.

## Low-level Transverter Interface Jack

The rear panel of the FT-2000 includes a low-level (0.1 mW) output jack ideal for connecting to VHF and UHF transverters.

## A CW Enthusiast's Dream Come True

### CW Zero-in Feature

With the FT-2000, you can use both your ears and your eyes to zero in on another CW station. The sidetone generated when you transmit (as set by the CW Pitch selection, with a range of 300-1050 Hz), allows you to match that pitch to that of an incoming signal perfectly. As you tune closer and closer to that pitch, the CW Tuning Indicator provides a graphical depiction of the tuning process, with a marker lighting up when the incoming signal is precisely aligned with yours.



### CW Spot Feature

The CW SPOT switch engages a spotting tone that matches the offset of your transmitted signal (as set by the CW Pitch selection), allowing you to match that pitch to that of an incoming signal perfectly. There's no more powerful way to be sure you're exactly on frequency.



### Additional CW Capabilities

- Separate KEY jacks on the front and rear panels
- Built-in Electronic Keyer with 4-60 WPM Speed control
- Electronic Keyer Weight control
- Keyer paddle Dot-Dash reversal
- "Bug" keying emulation
- CW Full Break-in
- Four-channel Message Memory (50 characters each); five memories available with optional FH-2 Keypad
- Automatic insertion of incrementing contest number into stored messages
- Automatic "Beacon" keyer mode
- CW "VOX" Delay is adjustable: 20 ms – 5000 ms
- CW Mode reversal (USB or LSB injection)
- CW keying available during SSB operation

## Leading-edge Features for the Serious Operator

### Contest-ready Antenna Selection Capabilities

The FT-2000 is designed with today's fast-moving contest operator in mind. Two TX/RX antenna jacks are provided on the rear panel, along with one RX-only jack, with one-touch access to any antenna. The antenna selection is memorized in each VFO and memory channel register, so you don't need to switch antennas when changing VFOs – the radio remembers which antenna you last used on that band or memory! And, if you have a special bandpass or other filter you want to engage, "In" and "Out" jacks for the RX-only path are also provided.

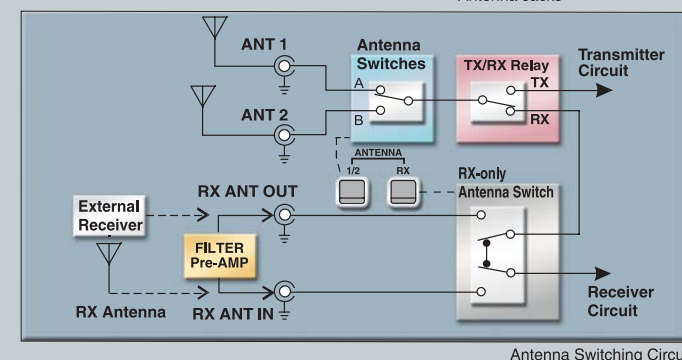

### Built-in TCXO for State-of-the-Art Stability

A highly-stable Temperature-Compensated Crystal Oscillator (TCXO) is built into every FT-2000, providing 0.5 ppm stability at room temperature, and better than 1 ppm stability over an ambient temperature range of 14° to 122° F (-10° to +50° C), making the FT-2000 ideal for PSK31, EME or other applications requiring high stability.

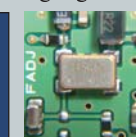
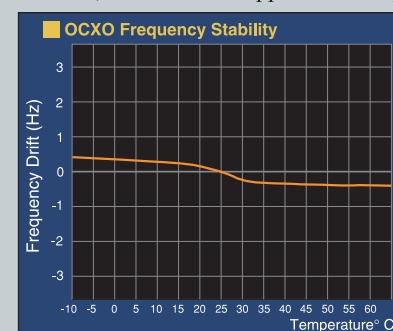

### "My Bands" Feature

In order to increase operating efficiency, you may use the Menu system to command the FT-2000 "skip" over any Amateur bands on which you do not operate (because you don't have an antenna for that band, etc.). For example, for contest operation, you do not need to use the 10/18/24 MHz bands, so you may eliminate them from the band stepping sequence, if you like.

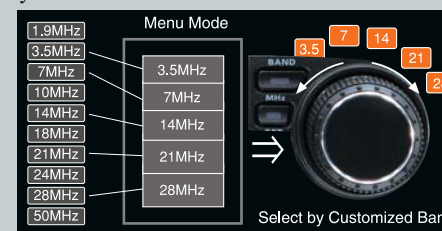

## CS Key

The CS (Custom Selection) key, located below and to the left of the Main tuning Dial, lets you select any Menu item for one-touch access via the CS key. This lets you bring up a favorite Menu item without having to scroll through the many available Menu selections.

## And Much, Much More...

- Quick Memory Bank (QMB) for instant storage and recall of frequency/mode information when you're in a hurry
- Digital voice Recorder for storage of 15-second "loop" of incoming receiver audio
- Four-channel message memory for repetitive voice messages ("CQ Contest..."), with each channel capable of storing up to 20 seconds of audio. With the optional FH-2 Keypad, 5 channels may be stored
- Optional FH-2 Keypad provides message storage and recall of voice and CW messages, along with remote control functions
- VOX (Voice-operated TX/RX control).
- MOX (Manual TX/RX control)
- All-mode Squelch
- 50-tone CTCSS Encoder/Decoder for FM operation
- Band-Specific Repeater Shifts for 29/50 MHz FM
- Wide/Narrow modes for AM and FM
- LOCK feature
- Flexible, easy-to-use VFO/Memory command selections: A → B, A ↔ B, V/M, M → A, A → M
- Memory Channel Offset Tuning (MT)
- Versatile Scanning Capability
- Versatile Menu Mode for customization of setup and features
- Constant-level rear-panel sound recording jack
- Comprehensive external RS-232C computer control (CAT) protocol
- The front panel of the FT-2000 includes control keys allowing you to control the speed and direction of a YAESU G-800DXA, G-1000DXA, or G-2800DXA rotator (supported rotators current as of September 2006), with front panel display of these parameters

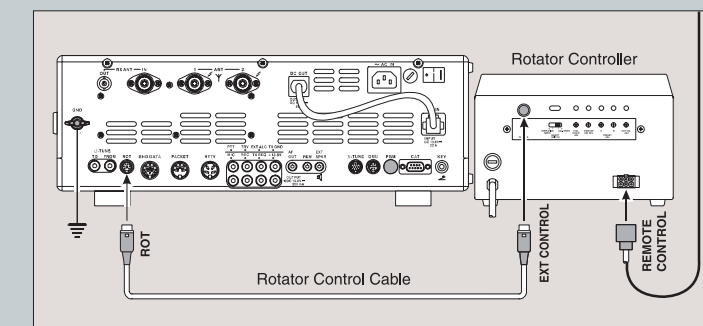

- Flexible and Easy Connection Points for RTTY, SSTV, PSK31, JT65 (EME) and other Digital Modes
- Optional VL-1000 Quadra System Linear Amplifier provides fully-automatic operation
- General coverage reception: 30 kHz – 60 MHz (specifications guaranteed only in Amateur bands)
- Mode-optimized Automatic AGC decay selection (OFF/SLOW/MID/FAST)
- Versatile Memory system: 99 channels and up to 5 Memory Groups
- Four-position receiver front-end attenuator (0/6/12/18 dB) for operation on noisy bands or when very strong signals are present



# Optional External Data Management Unit (DMU-2000) Provides Wide Display Capabilities

A wide array of informative and useful displays, identical to those available on the FT DX 9000D, can be obtained by adding the optional DMU-2000 Data Management Unit and an after-market display (not supplied) and your own personal computer. Enjoy the ultimate in operating ease by adding the DMU-2000!



Photograph shows 100-Watt version. Computer display and keyboard are after-market items, not supplied with the FT-2000.

## FT-2000 Series

### Audio Scope/Oscilloscope Display Page

When you have connected your after-market monitor to the DMU-2000 the Audio Scope and Oscilloscope "page" of the display may be the most-used capability of the Data Management Unit. The Audio Scope portrays the audio spectrum of either the receiver passband or your transmitted signal, allowing you to visualize the frequency components as you hear them. Then you can make adjustments to, for example, the Notch Filter, Contour control or (on transmit) the Parametric Microphone Equalizer. At the same time, you may use the Oscilloscope to look at the X-Y characteristics of an incoming signal, with variable level and sweep speed. The Audio Scope also includes a two-speed "Waterfall" display that is very useful for precise tuning of digital signals, or for Notch Filter adjustments.

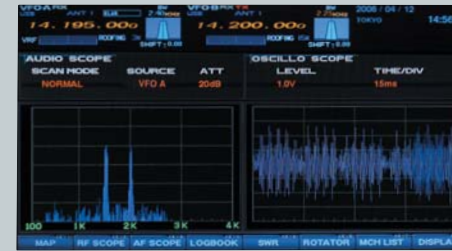

Spectrum Display



Waterfall Display

### World Clock Page

The World Clock page includes a world map with entries for a number of locations throughout the world, so you can know what the time of day is anywhere. Of great usefulness to DXers is the Sunrise/Sunset depiction, which shows the "Gray Line" area where propagation frequently is enhanced. An alarm feature is also included, to alert you of a schedule time.



### Rotator Control Page

The Rotator Control page lets you control the left/right rotation of your Yaesu G-800/1000/2800DXA series rotator, in addition to permitting speed control and setup of preset beam headings. And, if you use your after-market keyboard for input of your latitude and longitude, the DMU-2000 will lay out and display a Great Circle Map centered on your location! You may also connect a GPS Unit (one capable of output of NMEA0183 position data) to your DMU-2000 in order to download precise position data. The Great Circle Map allows you to aim your antenna accurately, and the imbedded database of worldwide cities may be used to determine a specific bearing to a DX location, if you like.



### Swept-Frequency SWR Page

As you tune across the Amateur band and transmit at different frequencies, the DMU-2000 will plot the SWR across the band, alerting you to any unusual SWR situations, etc.



### Memory Channel List

The 99 available memories may be grouped into as many as five Memory Groups, and all these memories may be viewed on the Memory Channel Listing page. You may add an alpha/numeric "Tag" to each memory, as well, for quick recall of the channel's identification.

NO	FREQUENCY	MODE	CH TAG	RPT	TOUR	FREQ
01	14.195.000	FM				
02	14.200.000	FM				

### Log Book Feature

By connecting an after-market keyboard and monitor to the DMU-2000, you can utilize the on-board Logging capability of the FT-2000. The Log Book includes an extensive database of DX information, and you may archive log data to the supplied CF card using one of the popular logging formats like ADIF, Cabrillo, etc.

DATE	TIME	CALL	PSY	RST	BAND	MODE	REH

### DMU-2000 Data Management Unit (option)



Inside the DMU-2000

### Spectrum Scope with LBWS

The RF Band Scope allows you to view activity within a span of 25 kHz, 100 kHz, 250 kHz, 500 kHz, 1 MHz, or 2.5 MHz, depending on your requirements, with a fixed sweep speed for seamless transition between spans.

Additionally, the YAESU-exclusive LBWS (Limited Band Width Sweep) allows you to reduce the bandwidth to 50%, 30%, or 10% of the original, imparting a corresponding increase in the sweep speed, if you like. By sweeping just a limited portion of the main Band Scope at high speed, you get a superbly detailed view of activity in that segment of the overall band, allowing you precise zero-in capability not found on competing products. With a 50% reduction, you get double the speed; with reduction to 30% of the original sweep, you get a 3X increase in speed, and by reducing the bandwidth to 10% you get a whopping 10X increase in the sweep speed. You can use the ◀ and ▶ keys to move the remaining window, as desired.

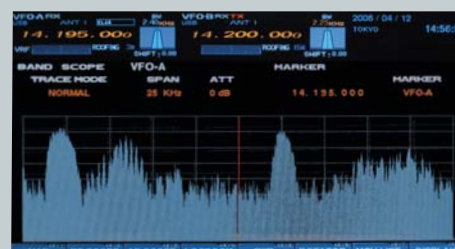



**Rear Panel (100-Watt version)**

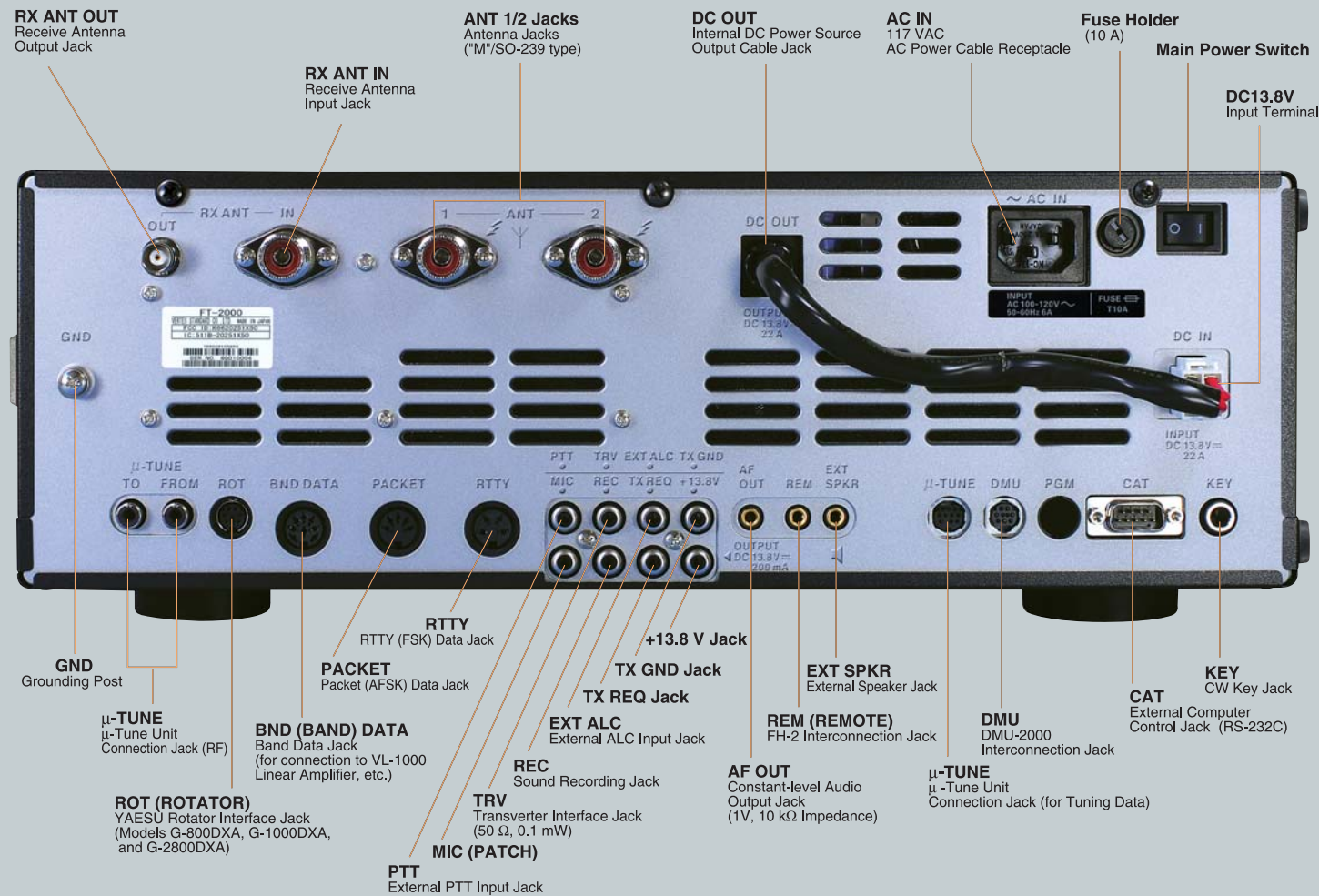

**Top View**



**Bottom View**

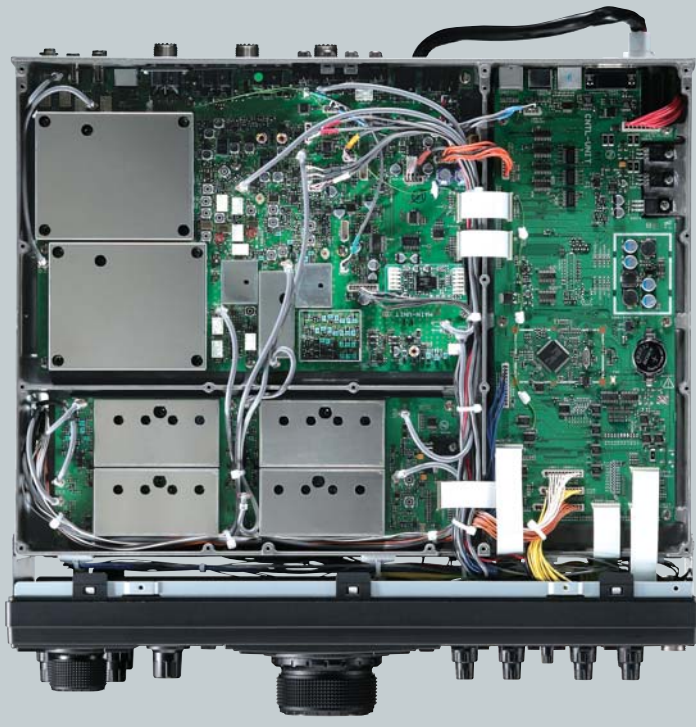

•Supplied Accessories: MH-31B8 Hand Mic, AC Cable, RCA Plugs (2), 3.5 mm Mono Plug (1) 3.5 mm Stereo Plug (1), 1/4" (6 mm) Stereo Plug (1), 4-pin DIN Plug (1), 5-pin DIN Plug (1).

**Options**

**SP-2000 External Speaker with Audio filters**

The SP-2000 features a large (4.7"/120 mm) speaker aperture, along with a three-selection High-Cut and two-selection Low-Cut Audio Filter system. Selection of the cutoff frequencies may be performed from the front panel of the speaker: 2.4 kHz/1 kHz/700 Hz for High-Cut, and 500/300 Hz for Low Cut. A headphone jack is provided on the front panel, allowing you to connect headphones and enjoy the benefits of the audio filtering within the SP-2000.



•Includes Scope Unit CF Card Unit

**DMU-2000**  
Data Management Unit

After-market PS/2 Keyboard and personal computer monitor are required for use of DMU-2000 and are not supplied.

**RF μ-Tune Kits**

<p><b>160m Band RF μ-Tune Kits A</b></p>	<p><b>80/40m Band RF μ-Tune Kits B</b></p>	<p><b>30/20m Band RF μ-Tune Kits C</b></p>
--	--	--

•Up to three μ-Tune Kits may be connected. • μ-Tune Kit is included in purchase price of μ-Tune Unit.

**Sub Receiver Collins® Mechanical CW Filters**  
(One may be installed)

**YF-122C** (500 Hz)  
**YF-122CN** (300 Hz)

**MD-200A8x**  
Desktop Deluxe Dynamic Microphone

**MD-100A8x**  
Desktop Microphone

**YH-77STA**  
Stereo Headphones

**FH-2**  
Remote Control Keypad

**QUADRA SYSTEM**

**HF-50** 50 MHz 1 KW Linear Amplifier (50 MHz: 500 W/USA Version)  
**VL-1000** Automatic Antenna Tuner Built In

**VP-1000**  
Power Supply



Specifications	FT-2000 100 W Version	FT-2000D 200 W Version
<b>General Specifications</b>		
Rx Frequency Range	30 kHz - 60 MHz (operating) 160 - 6 m (specified performance, Amateur bands only)	
Tx Frequency Ranges	160 - 6 m (Amateur bands only)	
Frequency Stability	±0.5 ppm (@ 77° F/25° C)	
Operating Temperature Range	14° F ~ +122° F (-10° C ~ +50° C)	
Emission Modes	A1A (CW), A3E (AM), J3E (LSB, USB), F3E (FM), F1B (RTTY), F1D (PACKET), F2D (PACKET)	
Frequency Steps	1/10 Hz (SSB, CW, & AM), 100 Hz (FM)	
Antenna Impedance	50 Ohms, unbalanced 16.7 - 150 Ohms, unbalanced (Tuner ON, 160 - 10 m Amateur bands) 25 - 100 Ohms, unbalanced (Tuner ON, 6 m Amateur band)	
Power Consumption (@117 VAC)	Rx (no signal) 70 VA Rx (signal present) 80 VA Tx (100 W) 450 VA Tx (200 W) 720 VA	
Supply Voltage	AC: 90 VAC - 132 VAC or 180 VAC- 264 VAC DC: 13.8 V ±10 %	
Dimensions (WxHxD)	16.1" x 5.3" x 13.8" (410 x 135 x 350 mm)	
Weight (approx.)	33 lbs (15 kg)	38.5 lbs (17.5 kg)
<b>Transmitter Specifications</b>		
Power Output	5 W ~ 100 W 2 W ~ 25 W (AM)	10 W ~ 200 W Class-A (SSB) 10 W ~ 75 W 5 W ~ 50 W (AM)
Modulation Types	J3E (SSB): Balanced, A3E (AM): Low-Level (Early Stage), F3E (FM): Variable Reactance	
Maximum FM Deviation	±5.0 kHz±2.5 kHz	
Harmonic Radiation	Better than -60 dB (160 - 10m Amateur bands) Better than -70 dB (6m Amateur band)	
SSB Carrier Suppression	At least 60 dB below peak output	
Undesired Sideband Suppression	At least 60 dB below peak output	
Audio Response (SSB)	Not more than -6 dB from 300 to 2700 Hz	
3rd-order IMD	-31 dB (14 MHz 100 W)	-31 dB (14 MHz 200 W) -45 dB (14 MHz 75 W Class-A)
Microphone Impedance	600 Ohms (200 to 10 kOhms)	

	FT-2000 100 W Version	FT-2000D 200 W Version
<b>Receiver Specifications</b>		
Circuit Type	Main (VFO-A); Triple-conversion superheterodyne Sub (VFO-B); Double-conversion superheterodyne	
Intermediate Frequencies	Main (VFO-A); 69,450 MHz/450 kHz/30 kHz (24 kHz for AM/FM), Sub (VFO-B); 40,455 MHz/455 kHz	
Sensitivity (RF AMP 2 "ON")	SSB (2.4 kHz, 10 dB S+N/N) 2 µV (0.1 - 1.8 MHz) 0.2 µV (1.8 - 30 MHz) 0.125 µV (50 - 54 MHz) AM (6 kHz, 10 dB S+N/N, 30 % modulation @400 Hz) 6 µV (0.1 - 1.8 MHz) 2 µV (1.8 - 30 MHz) 1 µV (50 - 54 MHz) FM (BW: 15 kHz, 12 dB SINAD) 0.5 µV (28 - 30 MHz) 0.35 µV (50 - 54 MHz)	
Selectivity	Main (VFO-A) Mode -6 dB -60 dB CW/RTTY/PKT 0.5 kHz or better 750 Hz or less SSB 2.4 kHz or better 3.6 kHz or less AM 6 kHz or better 15 kHz or less FM 15 kHz or better 25 kHz or less (WIDTH: Center, VRF: OFF) Sub (VFO-B) Mode -6 dB -60 dB CW/RTTY/PKT 1.1 kHz or better 3.0 kHz or less SSB 2.2 kHz or better 4.5 kHz or less AM 6 kHz or better 25 kHz or less FM 12 kHz or better 30 kHz or less	
Image Rejection	70 dB or better (160 - 10m Amateur bands) 60 dB or better (6m Amateur band)	
Maximum Audio Output	2.5 W into 4 Ohms with 10% THD	
Audio Output Impedance	4 to 8 Ohms (4 Ohms: nominal)	
Conducted Radiation	Less than 4000 µµW	

#### FP-2000 (External Power Supply for FT-2000D) Specifications

Power Requirements	AC90V~264V 50/60Hz
Current Consumption (@117V AC)	Typ. 720 VA maximum (with FT-2000D switched on)
Output Voltage	DC50V / 10A, DC13.8V / 5A
Weight (approx.)	8.8 lbs (4 kg)
Dimensions (WxHxD)	3.9" x 5.3" x 13.8" (100×135×350 mm)

#### DMU-2000 Data Management Unit Specifications

Power Requirements	AC90V~264V 50/60Hz
Current Consumption (@117V AC)	Typ. 50 VA
Weight (approx.)	6.8 lbs (3.1 kg)
Dimensions (WxHxD)	3.9" x 5.3" x 13.8" (100×135×350 mm) (without knobs/switches)

Specifications are subject to change, in the interest of technical improvement, without notice or obligation, and are guaranteed only within the amateur bands.

About this brochure: We have made this brochure as comprehensive and factual as possible. We reserve the right, however, to make changes at any time in equipment, optional accessories, specifications, model numbers, and availability. Precise frequency range may be different in some countries. Some accessories shown herein may not be available in some countries. Some information may have been updated since the time of printing; please check with your Authorized Yaesu Dealer for complete details.



**VERTEX STANDARD CO., LTD.**  
4-8-8 Nakameguro, Meguro-ku, Tokyo 153-8644, Japan

For the latest Yaesu news, visit us on the Internet:  
<http://www.vxstd.com>

**VERTEX STANDARD** <http://www.vertexstandard.com>  
Email: [amateursales@vxstdusa.com](mailto:amateursales@vxstdusa.com)

**US Headquarters** Phone +1 714-827-7600  
10900 Walker Street, Cypress, CA 90630, U.S.A.

**YAESU EUROPE B.V.**

P.O. Box 75525, 1118 ZN Schiphol, The Netherlands Phone +31 20-5005270

**YAESU UK LTD.** <http://www.yaesu.co.uk>  
Email: [sales@yaesu.co.uk](mailto:sales@yaesu.co.uk)

Unit 12, Sun Valley Business Park, Winnall Close Phone +44 196 286 6667  
Winchester, Hampshire, SO23 0LB, U.K.

**VERTEX STANDARD HK LTD.** <http://www.vxstd.com.hk>

Unit 5, 20/F., Seaview Centre, 139-141 Hoi Bun Road, Phone +852 2732 2288  
Kwun Tong, Kowloon, Hong Kong

**VERTEX STANDARD AUSTRALIA PTY. LTD.**

Normanby Business Park, Unit 14/45 Normanby Road Phone +61 3 95182100  
Notting Hill 3168, Victoria, Australia